



# EX SERIES MANUAL

欢迎您选购惠威车用扬声器系统。为了便于您的安装及使用，我们编写本折页。请务必在安装使用之前，仔细阅读并清楚了解安装程序及注意事项，依据不同型号的扬声器系统，采用不同的安装方式。

虽然本折页说明了安装的方式，但是对于汽车拆装并没有作说明，假如您没有这方面的经验，请不要自行安装，您可以去有经验的汽车服务处进行咨询。

——请特别注意您的汽车处于熄火状态！

## 一、线路图：请按照以下线路图连接

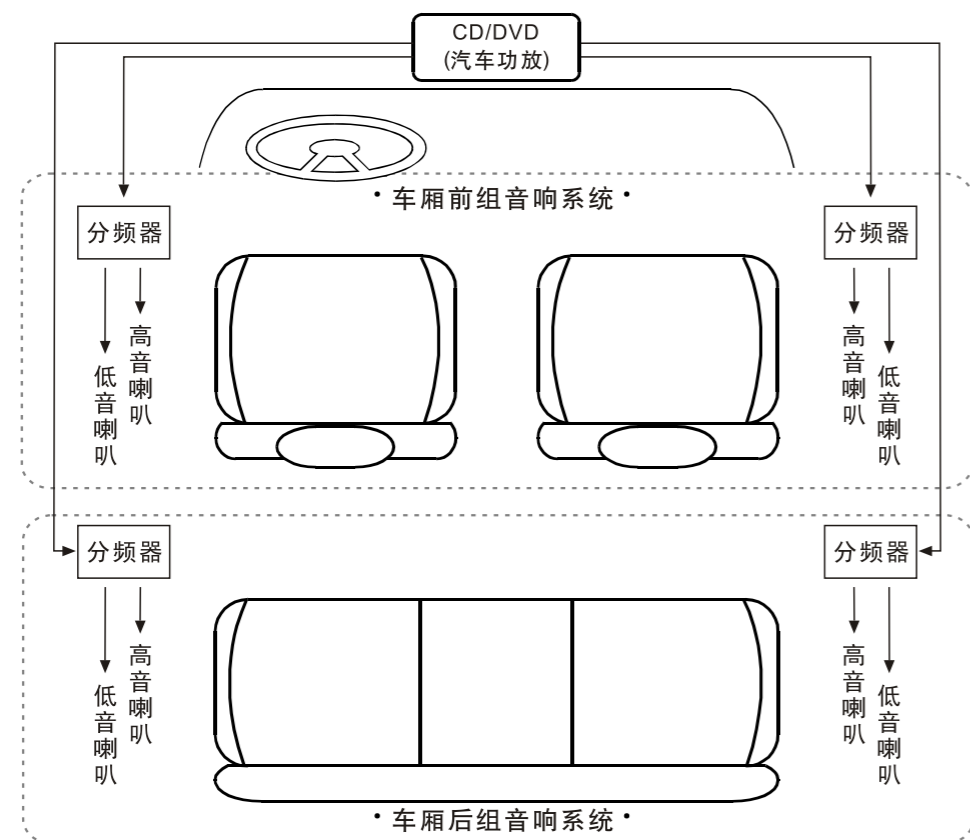

## 二、高音喇叭安装

方式一(如图1)：如不想改变车结构，将高音安装在仪表盘前方或车门边，可以采用此方式。

- 1、取半圆形双面自粘EVA，去除一面保护纸后将它粘在高音喇叭的安装位(如图)。
- 2、将自粘EVA的另一面保护纸去除，然后将喇叭粘在选定的位置。
- 3、调整喇叭方向，以便达到理想的听音效果。

注：此种方式优点在于可以完全不对车进行改变；缺点是不能很牢固的固定高音。



图1

方式二(如图2)：要想牢固地将高音安装在仪表盘前方或车门边，可以采用此种安装方式。

- 1、先用“一字”螺丝刀将高音喇叭的前盖打开。
- 2、按图示将安装螺丝穿过后盖、安装板，将高音喇叭的后盖锁紧在选取的位置。
- 3、将喇叭装入后盖内、压紧前盖。

4、调整喇叭的方向，以便达到理想的听音效果。

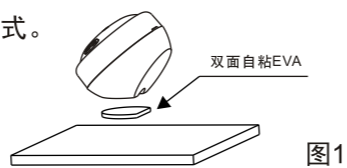
注：此种方式需在车上锁螺丝，故在安装前须确定高音喇叭的安装位置。



图2

## 三、低音喇叭安装(如下图3)：

- 1、依实际需要将密封垫片贴于喇叭的安装位。
- 2、螺丝穿过装饰网及喇叭安装孔将喇叭锁紧。
- 3、当安装深度不够时，可以在喇叭的安装位加一垫圈以增加安装深度。

## 四、分频器安装(如下图4)：

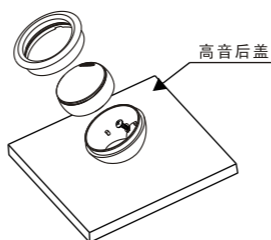
- 1、按图示将安装螺丝穿过分频器，将分频器锁紧在车门内或其他选定位置。

## 五、接线方法(如下图5)：

- 1、分频器与高音、低音连接示意图。

注：依个人喜好将高音调节为“+2dB、0dB、-2dB”三种状态。



图3

图4

图5

## 六、规格：

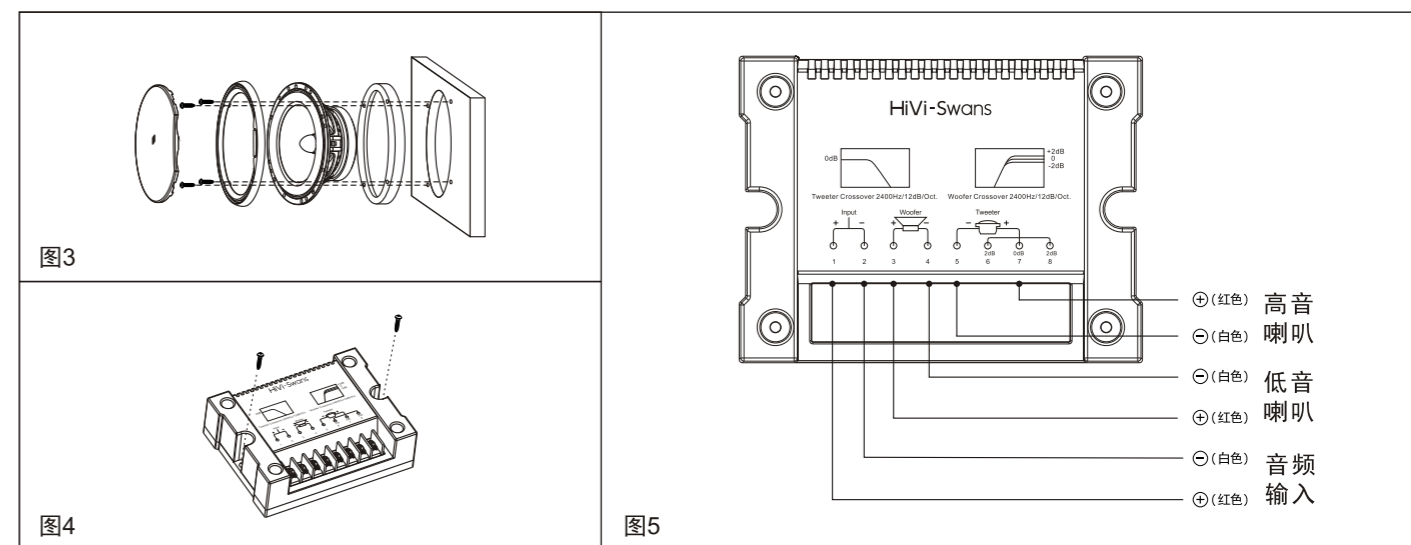
型号	EX-165	EX-260	EX-265
中低音	EX6B	EX6F	EX6S
高音	DX28B	DX28B	KX26T
灵敏度	88dB	88dB	88dB
频率响应	50Hz-20KHz	50Hz-20KHz	50Hz-20KHz
最大功率	100W	100W	100W
额定功率	50W	50W	50W
额定阻抗	4Ω	4Ω	4Ω
安装尺寸	Φ157mm	Φ157mm	Φ157mm
开孔尺寸	Φ148.5mm	Φ148.5mm	Φ148.5mm
安装深度	>68mm	>68mm	>68mm
网罩尺寸	Φ172X22mm	Φ172X22mm	Φ172X22mm
高通衰减斜率	12dB/Octave	12dB/Octave	12dB/Octave
低通衰减斜率	12dB/Octave	12dB/Octave	12dB/Octave

惠威车用扬声器系统  
www.hivi.com

因设计变更等原因，所示资料可能与实物不符，恕不另行通知



# EX SERIES MANUAL

Thank you for your purchase of HiVi Car-Audio Speaker Systems. Please read the following installation and operation guidelines carefully to ensure many years enjoyment of car audio speaker system. All HiVi Speaker Systems products should be set-up and installed by authorized and licensed technicians.

Though this manual narrates the installation, it didn't show the remove of car. If you got no experience of this, please don't set up by yourself, you can inquire at the experienced car service office.

———— Please note your car is on flameout situation!

Circuit diagram Please connect according to the following circuit diagram

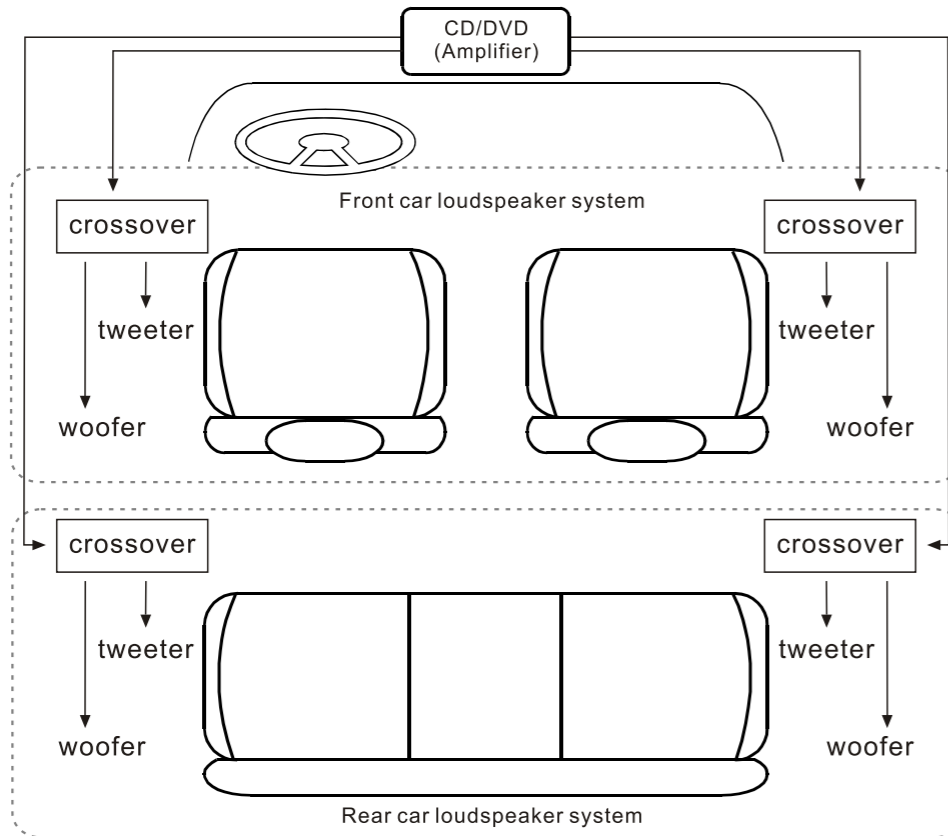

## Installation of Tweeter:

Option One (Figure1): if you don't want to change the structure of car, and install the tweeter before steering wheel or beside the door of car, then you can use this mode.

- 1、 Take semicircle double sides stick EVA, get rid of one side protecting paper and stick this on the place of installation of tweeter (as drawing).
- 2、 Get rid of another protecting paper of EVA, then stick speaker at the fixed place.
- 3、 Adjust the orientation of speaker so as to get the best sound quality.

Note: The merit of this kind of installation is that there's no need to change the car, the demerit is that can it fix the tweeter well enough.

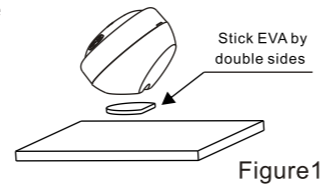

Option Two (Figure2): If you want to fix the tweeter before the steering wheel or beside the door of car, then you can use this mode.

- 1、 Use the "-" screwdriver open the front cover of tweeter.
- 2、 Use the screw threading the back cover, installation plate, then fix the back cover of speaker on the selected place as drawing.
- 3、 Put the speaker into the back cover, press the front cover.
- 4、 Adjust the orientation of speaker so as to reach the best sound quality.

Note: This kind of installation needs to lock the screws on the car, so you have to fix the place of tweeter before installation.

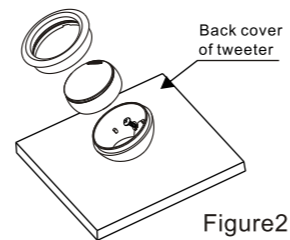

## Installation of Woofer (Figure3):

- 1、 According the demand then stick the gasket on the place of Installation.
- 2、 Drive the screws through the grill and into the installation holes, and then fasten the screws.
- 3、 If the depth is not enough, can use some mate on the place of installation then can add some depth.

## Installation of crossover (Figure4):

- 1、 Pass supplied screws through crossover as illustrated, install crossover securely inside car door or other desired position.

## Connection (Figure5):

- 1、 The drawing of crossover and tweeter, woofer Adjust high frequency output to +2dB, 0dB, -2dB as per your preference on the crossover.

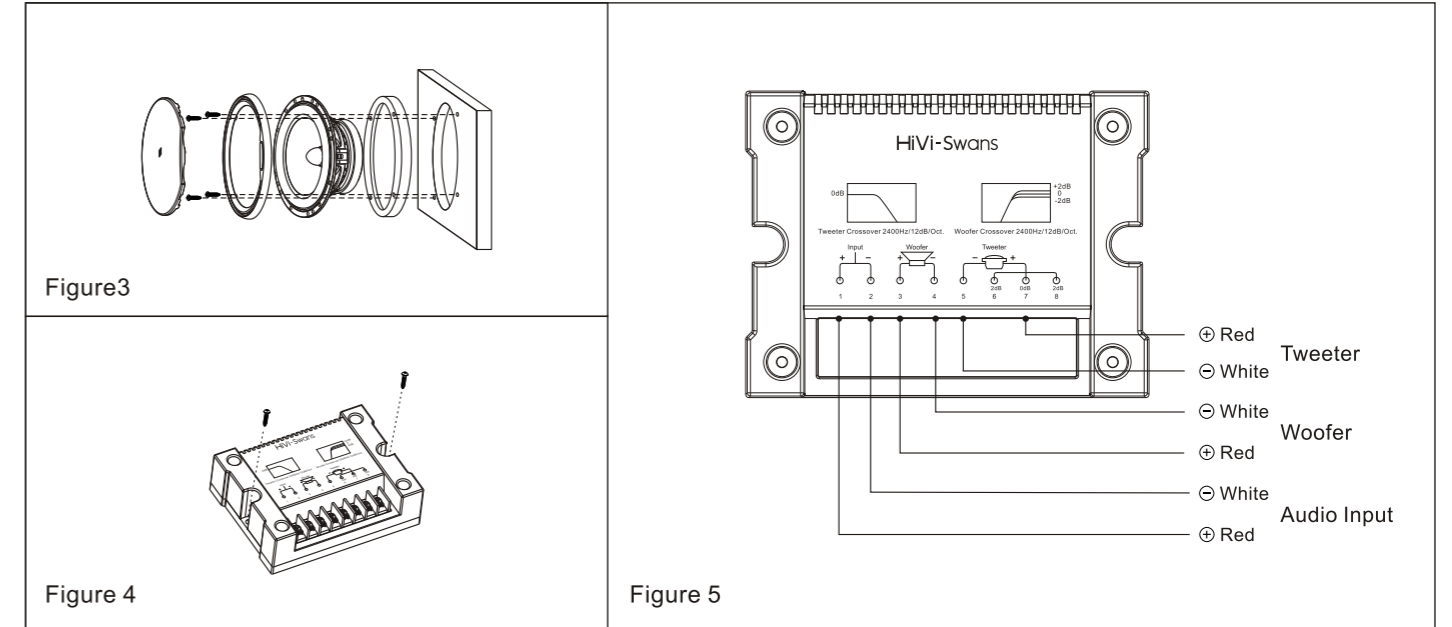

## Specifications:

Model	EX-165	EX-260	EX-265
Woofer	EX6B	EX6F	EX6S
Tweeter	DX28B	DX28B	KX26T
Sensitivity	88dB	88dB	88dB
Frequency Response	50Hz-20KHz	50Hz-20KHz	50Hz-20KHz
Max Power	100W	100W	100W
Power Handling	50W	50W	50W
Rating Impedance	4Ω	4Ω	4Ω
Installation Size	Φ157mm	Φ157mm	Φ157mm
Hole Size	Φ148.5mm	Φ148.5mm	Φ148.5mm
Installation Depth	>68mm	>68mm	>68mm
Net size	Φ172X22mm	Φ172X22mm	Φ172X22mm
High pass decay rate	12dB/octave	12dB/octave	12dB/octave
Low pass decay rate	12dB/octave	12dB/octave	12dB/octave

HI-END CAR LOUDSPEAKER SYSTEM  
www.hivi.com

Because of the design change, the illustration may not conform to the practicality. We will not inform again!